



Perfecting the Air



INVERTER AIR COOLED PACKAGED AIR CONDITIONERS

FLOOR STANDING TYPE

DUCT TYPE



www.netivocooling.com
www.netivocool.com

R-410A

COOLING ONLY 50Hz



DIRECT AIR BLOW DUCT CONNECTION

FLOOR STANDING TYPE

DUCT TYPE

OUTDOOR UNIT

Inverter Packaged Air Conditioner Line Up for Factories and Offices

Product Line Up **R-410A**

RZUR-P Series

Cooling only

50Hz

Capacity	kW Btu/h	20.5 70,000	26.4 90,000		
FLOOR STANDING TYPE (DIRECT AIR BLOW)					
		FVGR08PV2SR1	FVGR10PV2SR1		
OUTDOOR UNIT					
		RZUR08PY2S	RZUR10PY2S		

RZUR-Q Series

Cooling only

Enhanced lineup

Wider capacity range with 2 new lineups of 12 and 20 HP

50Hz

Capacity	kW Btu/h	23.2 79,000	28.9 99,000	34.7 ^{New} 118,000	46.3 158,000	52.0 177,000	57.7 ^{New} 197,000
FLOOR STANDING TYPE (DUCT CONNECTION)							
		FVPR10QY2S	FVPR12QY2S	FVPR16QY2S	FVPR18QY2S	FVPR20QY2S	
DUCT TYPE							
		FDR08QY2S	FDR10QY2S	FDR12QY2S	FDR16QY2S	FDR18QY2S	FDR20QY2S
OUTDOOR UNIT							
		RZUR08QY2S	RZUR10QY2S	RZUR12QY2S	RZUR16QY2S	RZUR18QY2S	RZUR20QY2S

DIRECT AIR BLOW

Direct air blow from indoor unit with plenum

- Comfortable factory air conditioning using multiple indoor units installed in accordance with the space.
- Installation is next to walls, so units will not affect the factory layout even if the changes are made.

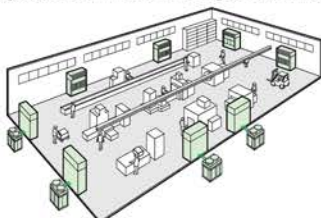

DUCT CONNECTION / DUCT TYPE

Air blow via connected ducts

- Comfortable air conditioning of the entire factory by connecting a blow duct at the top of the indoor unit.

Note: Ducts to be procured locally.

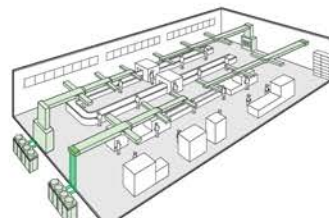

Cooling Capacity improvement

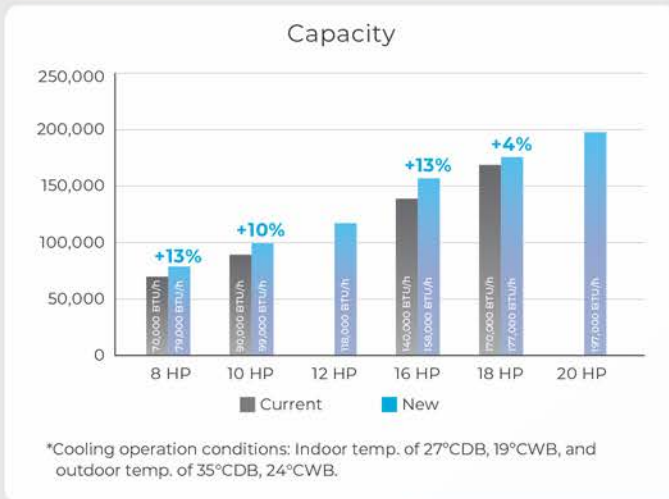

RZUR-Q series increase Cooling Capacity to full BTU/h to maximize product potential.



SEER Improvement

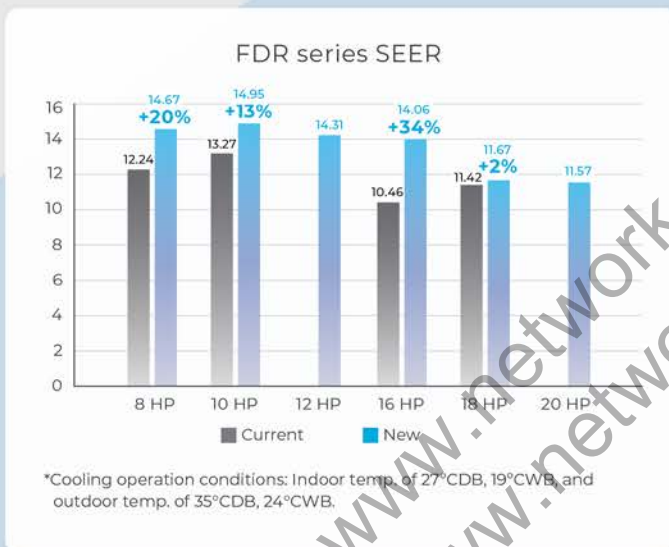

FDR-Q series provides greater energy saving due to higher SEER* as compared to FDR-P series.

*SEER: Seasonal Energy Efficiency Ratio



Design flexibility

Compact & lightweight design

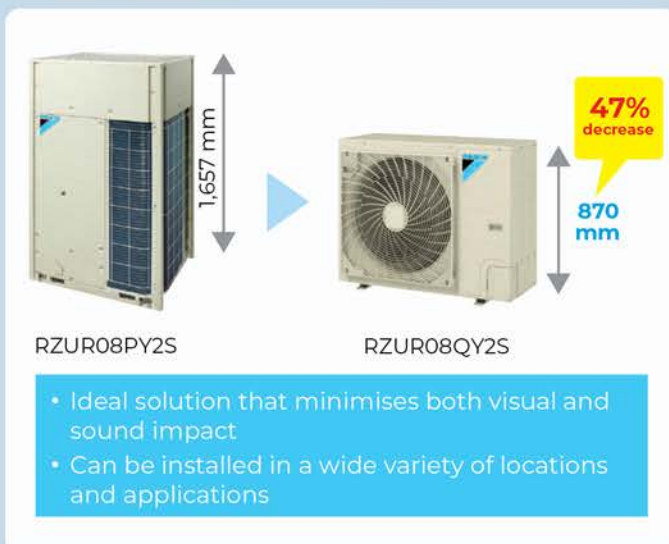

The new design has been optimised for the RZUR08QY2S with the height reduced to only 870 mm.

This low height casing design provides occupants with a clear, unobstructed view of the scenery.

Automatic adjustment of external static pressure New

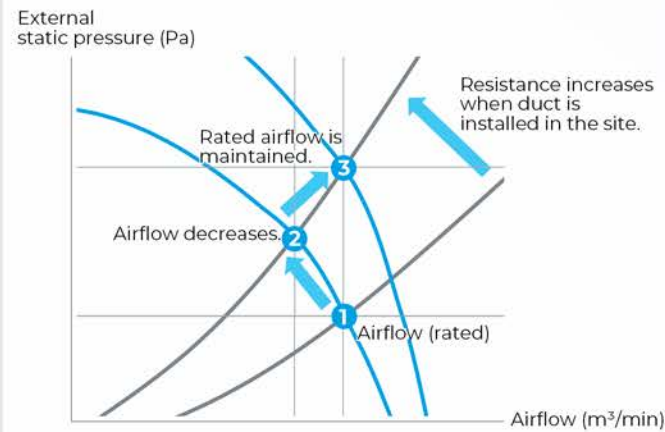

The RZUR08QY2S model has the external static pressure automatic adjustment function for maintaining the rated airflow and capacity by automatically adjusting the external static pressure during the test operation to suit the resistance of the installation site.

* For RZUR08QY2S Maximum Automatic Adjustment External Static Pressure is 40Pa. This function is set as default no field setting required.
 ** For Other models except RZUR08QY2S; High External Static Pressure Mode is up to 78.4Pa can be achieved via field setting.

Comfort

Long Air Throw 23 m.

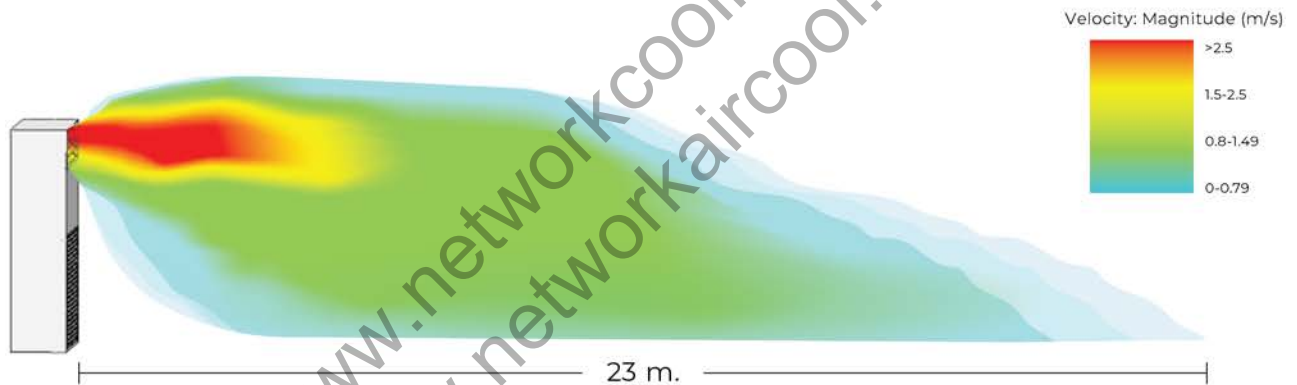

*For FVGR08/10PV2SR1 Test result from Daikin Airconditioning (Thailand) Ltd in May 2023 Test condition: Dry Bulb temperature 35 °C Wet Bulb temperature 26°C, Fan speed Setting: High, Operation mode: Fan(Fan only operation)

Nighttime quiet operation function

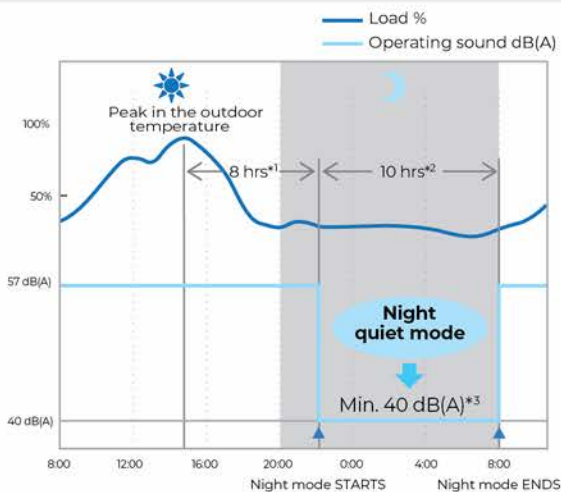

The nighttime quiet operation function automatically suppresses the nighttime operating sound by reducing operation capacity to maintain the quiet environment of the neighborhood. Three selectable modes are available depending on the required level.

- *1. Initial setting is 8 hours. Can be selected from 6, 8 and 10 hours.
- *2. Initial setting is 9 hours. Can be selected from 8, 9 and 10 hours.
- *3. In case of RZUR10PY2S and RZUR10QY2S.

Notes: · This function is available in setting at site.

- The operating sound in quiet operation mode is the actual value measured by our company.
- The relationship of outdoor temperature (load) and time shown above is just an example.

Reliability

Backup operation function

Compressor backup operation function

Emergency operation



Malfunction

* For RZUR12-20QY2S models. On-site settings are required using the PCB of the outdoor unit.

Centralized management system extension

High efficiency integrated control

Intelligent Touch Manager

Lighting and ventilation control, energy use can be monitored and managed by one controller.

Intelligent touch Manager

10.4 inch width touch screen



Centralized management can integrate with BACS system with high speed data transfer.

Centralized control is now available when using with Inverter packaged air conditioners.

Display of air filter cleaning times and self-inspection function for simple maintenance.

Auto restart

Automatically turn on the operation unit after facing unexpected shut down.

* Auto restart function can be turned ON/OFF by field setting

Automatic refrigerant charge function

Contribute to optimised operation efficiency, higher quality and easier installation.

Optimised operation efficiency New

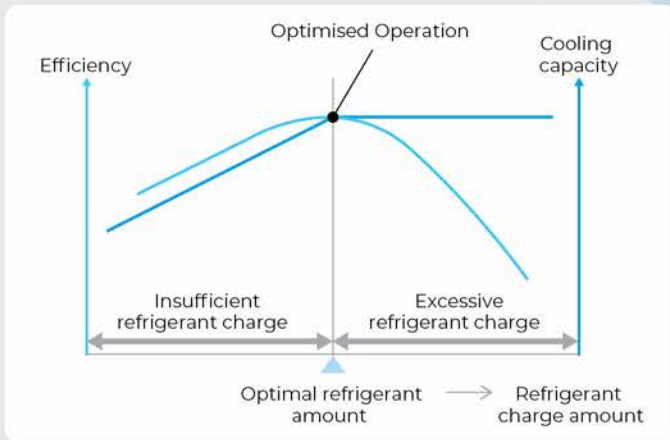

This function prevents a capacity shortage or energy loss due to excessive or insufficient refrigerant.

Higher quality and easier installation New

1 Calculation of necessary refrigerant amount from design drawing



2 Start of automatic refrigerant charge operation

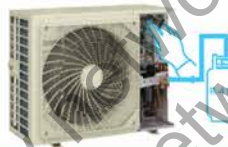

- Automatic completion by proper refrigerant amount
- Monitoring refrigerant charging is unnecessary
- No recalculation of charge amounts due to minor design changes locally

The automatic refrigerant charge function automates the charging of the proper refrigerant amount and easy start by pressing one button.

- * There are conditions in the range of ambient temperature in which the automatic refrigerant charge can be used. Refer to the installation manual for details.
- * The refrigerant amount that can be automatically charged may differ from the additional refrigerant amount that is provided from calculations, but there are no problems in performance and quality.

Enhanced varieties of factory modification

○ Standard model
 New functions Factory modification

Factory Modification	Floor Standing Type		Duct Type
	Direct Air Blow	Duct Connection	
Auto restart	○	○	○
Change fan motor and pulley	-	□	□
Discharge grill plenum chamber	○	□	□
Side discharge grill on discharge plenum chamber	□	□	-
Front suction high efficiency filter chamber	-	□	-
Front suction base flange for front suction high efficiency filter chamber	-	□	-
Suction grill for front suction high efficiency filter chamber	-	□	-
Rear suction	-	□	-
Drain pump	□	□	-
2 step airflow by toggle switch	□	-	-

Electricity Cost compare with Non-Inverter model

Electricity cost/year reduce **35%** averagely

SBU	Non-inverter		Inverter		Diff Electric cost/year	% Reduce
	Model	Electric cost / Year	Model	Electric cost / Year		
Duct	AFDR08NY1	102,578 THB	FDR08QY2S	62,269 THB	40,309 THB	39%
	AFDR10NY1	130,548 THB	FDR10QY2S	76,572 THB	53,976 THB	41%
	AFDR13NY1	170,170 THB	FDR12QY2S	96,565 THB	73,605 THB	43%
	AFDR15NY1	204,374 THB	FDR16QY2S	129,942 THB	74,432 THB	36%
	AFDR18NY1	243,841 THB	FDR18QY2S	175,380 THB	68,461 THB	28%
	AFDR20NY1	286,536 THB	FDR20QY2S	196,884 THB	89,652 THB	31%
Floor Direct blow	AFVR08NV1	98,069 THB	FVGR08PV2SR1	69,839 THB	28,230 THB	29%
	AFVR10NV1	128,057 THB	FVGR10PV2SR1	79,332 THB	48,725 THB	38%
Floor Duct Connection	AFPR10NY1	130,548 THB	FVPR10QY2S	82,238 THB	48,310 THB	37%
	AFPR13NY1	169,449 THB	FVPR12QY2S	120,217 THB	49,232 THB	29%
	AFPR15NY1	203,597 THB	FVPR16QY2S	140,214 THB	63,383 THB	31%
	AFPR18NY1	240,903 THB	FVPR18QY2S	161,666 THB	79,238 THB	33%
	AFPR20NY1	282,894 THB	FVPR20QY2S	179,508 THB	103,386 THB	37%

*Electric cost refer calculation method from ISO16358-1:2013 same method as EGAT Air Conditioning No 5 Label (Operating 8hr/day, Electric cost 3.96Baht/unit), Calculation base on same capacity(BTU/h)



Specifications

FLOOR STANDING TYPE

DIRECT AIR BLOW

Model Name	Indoor unit		Outdoor unit		FVGR08PV2SR1	FVGR10PV2SR1
	Outdoor unit				RZUR08PY2S	RZUR10PY2S
Rated cooling capacity ^{*1} (Min-Max.)	Btu/h				70,000 (22,900-74,000)	90,000 (19,100-96,000)
	kW				20.5 (6.7-21.7)	26.4 (5.6-28.1)
Power consumption ¹	kW				7.65	9.36
SEER					13.08	14.43
COP					2.68	2.82
Indoor unit	Power supply				1 Phase, 220 V, 50 Hz	
	Colour				Ivory White	
	Air flow rate (H/L)	m ³ /min			80/65	
		cfm			2,830/2300	
	Fan	Motor output	kW		0.245×2	
		Drive			Direct Drive 2 Speed	
	Dimensions (H×W×D)		mm		1,870×1,170×510	
	Machine weight		kg		149	
	Sound level		dB(A)		61/57	
Drain		mm		PS 1B Internal thread		
Outdoor unit	Power supply				3 Phase, 380 V, 50 Hz	
	Colour				Ivory white	
	Compressor	Type			Hermetically sealed scroll type	
		Motor output	kW		3.4×1	4.5×1
	Coil type				Cross Fin Coil	
	Air flow rate (H)	m ³ /min		178		
	Dimensions (H×W×D)		mm		1,657×930×765	
	Machine weight		kg		175	185
	Sound level ²		dB(A)		56	57
	Operation range		°CDB		10 to 49	
Refrigerant charge		kg		5.9	6.7	
Refrigerant Piping	Liquid	mm		Ø 9.5 (Brazing)		
	Gas	mm		Ø 19.1 (Brazing)	Ø 22.2 (Brazing)	
Max. piping length		m		70 (equivalent length 90 m)		
Max. level difference		m		50		
Safety Device				High Pressure Switch, Fan Driver Overload Protector, Overcurrent Relay, Inverter Overload Protector		

DUCT CONNECTION

Model Name	Indoor unit		Outdoor unit		FVPR10QY2S	FVPR12QY2S	FVPR16QY2S	FVPR18QY2S	FVPR20QY2S
	Outdoor unit				RZUR10QY2S	RZUR12QY2S	RZUR16QY2S	RZUR18QY2S	RZUR20QY2S
Rated cooling capacity ^{*1,4} (Min-Max.)	Btu/h				99,000 (21,000-100,000)	118,000 (45,000-120,000)	158,000 (44,000-160,000)	177,000 (47,000-180,000)	197,000 (47,000-200,000)
	kW				28.90 (6.1-29.30)	34.70 (13.3-35.20)	46.30 (12.9-46.90)	52.00 (13.7-52.80)	57.70 (13.7-58.60)
Power consumption ^{1,4}	kW				10.90	12.39	15.70	20.00	25.42
SEER					13.92	11.35	13.03	12.66	12.69
COP					2.65	2.80	2.95	2.60	2.27
Indoor unit	Power supply				3 Phase, 380 V, 50 Hz				
	Colour				Ivory White				
	Air flow rate (H)	m ³ /min			80	120			166
		cfm			2,830	4,240			5,860
	External static pressure ³		Pa		147			150	
	Fan	Motor output	kW				1.5		
		Drive					Belt Drive		2.2
	Dimensions (H×W×D)		mm		1,740×1,170×510	1,870×1,470×720		1,870×1,810×720	
	Machine weight		kg		151	251		297	
Sound level		dB(A)		61	67		66		
Drain		mm				PS 1B Internal thread			
Outdoor unit	Power supply				3 Phase, 380 V, 50 Hz				
	Colour				Ivory white				
	Compressor	Type			Hermetically sealed scroll type				
		Motor output	kW		4.5×1	(3.5×1)+(3.5×1)			(4.9×1)+(4.2×1)
	Coil type				Cross Fin Coil				
	Air flow rate (H)	m ³ /min		178	257			297	
	Dimensions (H×W×D)		mm		1,657×930×765			1,657×1,240×765	
	Machine weight		kg		185	260			291
	Sound level ²		dB(A)		57	60			65
	Operation range		°CDB		10 to 49				
Refrigerant charge		kg		6.7	8.2			11.7	
Refrigerant Piping	Liquid	mm		Ø 9.5 (Brazing)		Ø 12.7 (Brazing)		Ø 15.9 (Brazing)	
	Gas	mm		Ø 22.2 (Brazing)		Ø 28.6 (Brazing)			
Max. piping length		m		70 (equivalent length 90 m)					
Max. level difference		m		50					
Safety Device				High Pressure Switch, Fan Driver Overload Protector, Overcurrent Relay, Inverter Overload Protector					

Note: *1. Indoor temp.: 27°CDB, 19°CWB / outdoor temp.: 35°CDB, 24°CWB / Equivalent piping length: 7.5 m, level difference: 0 m.

*2. Anechoic chamber conversion value, measured at a point 1 m in front of the unit at a height of 1.5 m. During actual operation, these values are normally somewhat higher as a result of ambient conditions and oil recovery mode. When there is concern for noise in the surrounding area such as residences, we recommend investigating the installation location and taking soundproofing measures.

*3. The value is the external static pressure with standard pulley.

*4. Capacity are net, including a deduction for cooling for indoor fan motor heat.

DUCT TYPE

Model Name	Indoor unit		FDR08QY2S	FDR10QY2S	FDR12QY2S	FDR16QY2S	FDR18QY2S	FDR20QY2S	
	Outdoor unit		RZUR08QY2S	RZUR10QY2S	RZUR12QY2S	RZUR16QY2S	RZUR18QY2S	RZUR20QY2S	
Rated cooling capacity ^{*1,5} (Min-Max.)	Btu/h		79,000 (11,000-80,000)	99,000 (21,000-100,000)	118,000 (45,000-120,000)	158,000 (44,000-160,000)	177,000 (47,000-180,000)	197,000 (47,000-200,000)	
	kW		23.20 (3.1-23.50)	28.90 (6.1-29.30)	34.70 (13.3-35.20)	46.30 (12.9-46.90)	52.00 (13.7-52.80)	57.70 (13.7-58.60)	
Power consumption ^{*1,5}	kW		8.92	10.70	11.19	15.69	21.22	26.39	
SEER			14.67	14.95	14.13	14.06	11.67	11.57	
COP			2.60	2.70	3.10	2.95	2.45	2.19	
Indoor unit	Power supply	3 Phase, 380 V, 50 Hz							
	Colour	Ivory White							
	Air flow rate (H)	m ³ /min	78		120			166	
		cfm	2,750		4,240			5,860	
	External static pressure ^{*3}	Pa	98			150			
	Fan	Motor output	1.5					2.2	
		Drive	Belt Drive						
	Dimensions (H×W×D)	mm	500×1,330×850			625×1,980×850		760×2,195×870	
	Machine weight	kg	106			187		216	
	Sound level	dB(A)	57			59		60	
Drain	mm	PS 3/4B Internal thread			PS 1B Internal thread				
Outdoor unit	Power supply	3 Phase, 380 V, 50 Hz							
	Colour	Ivory white							
	Compressor	Type	Hermetically sealed swing type			Hermetically sealed scroll type			
		Motor output	3.2×1	4.5×1	(3.5×1)+(3.5×1)	(4.9×1)+(4.2×1)			
					Cross fin coil				
	Air flow rate (H)	m ³ /min	126	178	257			297	
	Dimensions (H×W×D)	mm	870×1,100×460	1,657×930×765		1,657×1,240×765			
	Machine weight	kg	113	185	260			291	
	Sound level ^{*2}	dB(A)	61	57	60			65	
	Operation range	°CDB	10 to 49						
Refrigerant charge	kg	3.8	6.7	8.2	11.7				
Refrigerant Piping	Liquid	Ø 9.5 (Brazing)			Ø 12.7 (Brazing)		Ø 15.9 (Brazing)		
	Gas	Ø 19.1 (Brazing)	Ø 22.2 (Brazing)		Ø 28.6 (Brazing)				
Max. piping length	m	70 (equivalent length 90 m)							
Max. level difference	m	50 ^{*4}			50				
Safety Device		High Pressure Switch, Fan Driver Overload Protector, Inverter Overload Protector, Fuse, Bimetal thermostat (Overload Relay)							

Note : *1. Indoor temp: 27°CDB, 19°CWB / outdoor temp: 35°CDB, 24°CWB / Equivalent piping length: 7.5 m, level difference: 0 m.

*2. Anechoic chamber conversion value, measured at a point 1 m in front of the unit at a height of 1.5 m.

During actual operation, these values are normally somewhat higher as a result of ambient conditions and oil recovery mode.

When there is concern for noise the surrounding area such as residences, we recommend investigating the installation location and taking soundproofing measures.

*3. The value is the external static pressure with standard pulley.

*4. Max. 40 m if the outdoor unit is lower than the indoor unit.

*5. Capacity are net, including a deduction for cooling for indoor fan motor heat

Option

FLOOR STANDING TYPE

Option	Direct Air Blow	Duct Connection		
	FVGR-PV2SR1	FVPR10QY2S	FVPR12/16QY2S	FVPR18/20QY2S
Discharge grill plenum chamber (Including pulley and belt)	—	BPCV10Q	BPCV16Q	BPCV20Q
Filter chamber	—	BFU1B250	BFU1B400	BFU1B500

DUCT TYPE

Option	FDR08QY2S	FDR10QY2S	FDR12QY2S	FDR16QY2S	FDR18QY2S	FDR20QY2S
Discharge grill plenum chamber (Including pulley and belt)	BPCD10Q			BPCD16Q		BPCD20Q

CONTROL SYSTEM

Option	FVGR-PV2SR1	FVPR-QY2S	FDR-QY2S
Simplified remote controller	BRCIC62-9 (Built-in)	BRC2E61 (Built-in)	BRC2E61
Navigator remote controller	—	BRCIE63	
Intelligent touch controller		DCS601C51	
Central remote controller		DCS302CA61	
Unified ON/OFF controller		DCS301B61	
Schedule timer		DST301BA61	
Wiring adaptor for electrical appendices (Group control adaptor) ★		KRP4AA51	
Wiring adaptor for electrical appendices ★	—	KRP2A61	
Adaptor for wiring ★	KRP1C67	—	
Adaptor for wiring (operation status output) ★	BRP11B61	—	
Remote sensor (for indoor temperature)	BRC501A-1	BRC501A-6	
Mounting plate for adaptor PCB ☆	—	BRP20A-3	BRP20A-2

Note : Mounting plate ☆ is necessary for each adaptor marked ★.

Fan Performance

FLOOR STANDING TYPE

DUCT CONNECTION

FVPR10QY2S

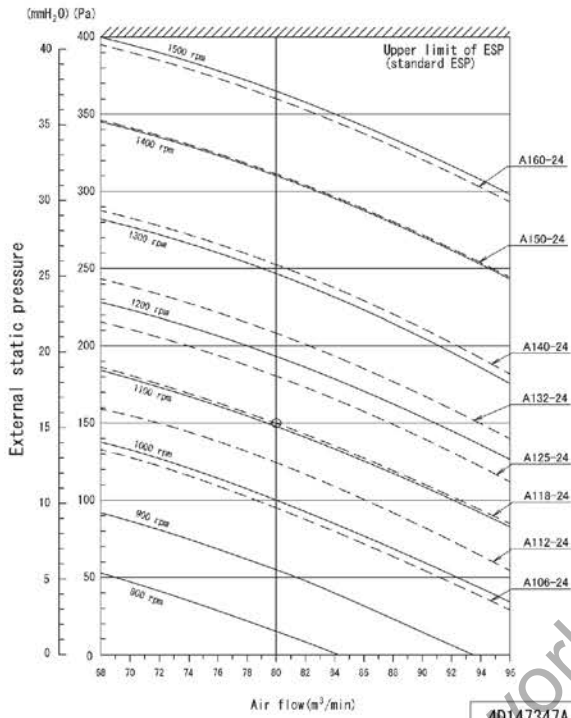

FVPR12QY2S
FVPR16QY2S

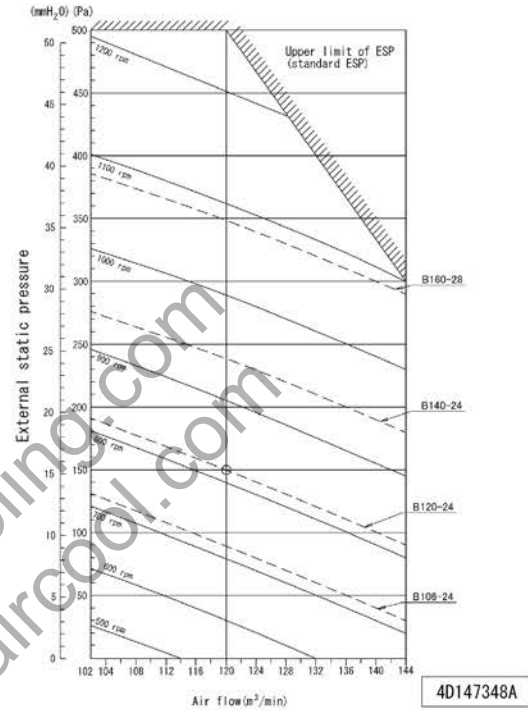

FVPR18QY2S
FVPR20QY2S

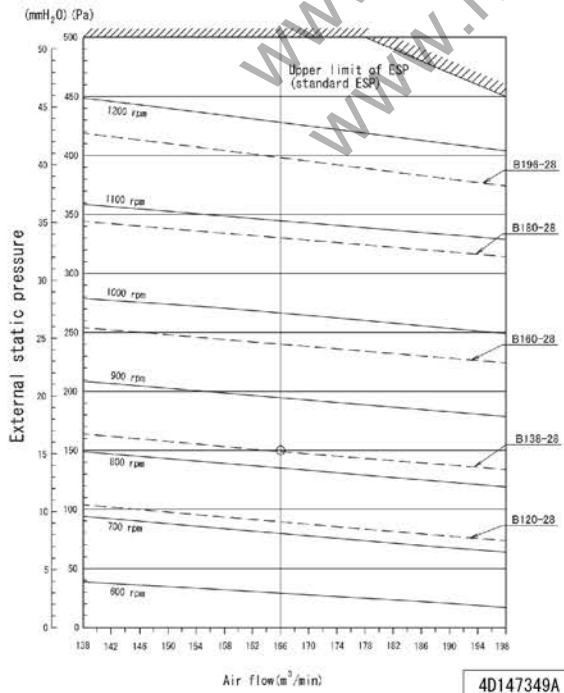

DUCT TYPE

**FDR08QY2S
FDR10QY2S**

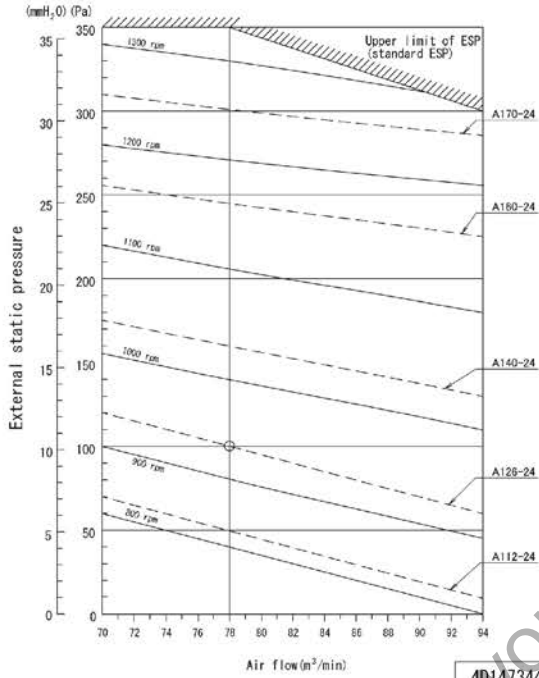

**FDR12QY2S
FDR16QY2S**

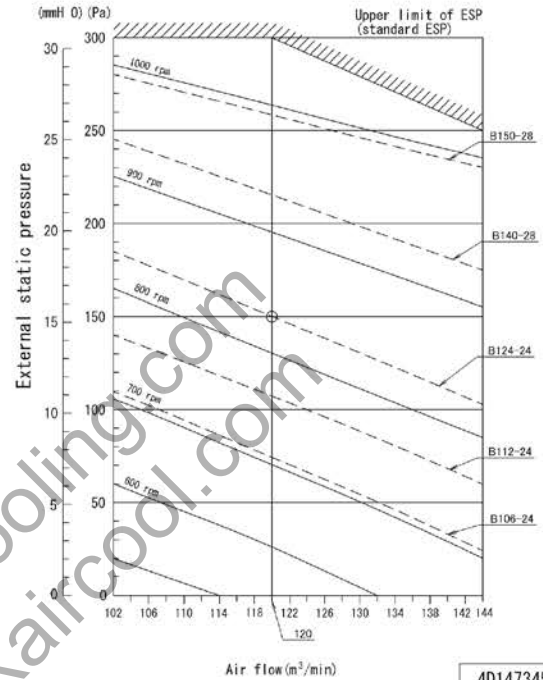

**FDR18QY2S
FDR20QY2S**

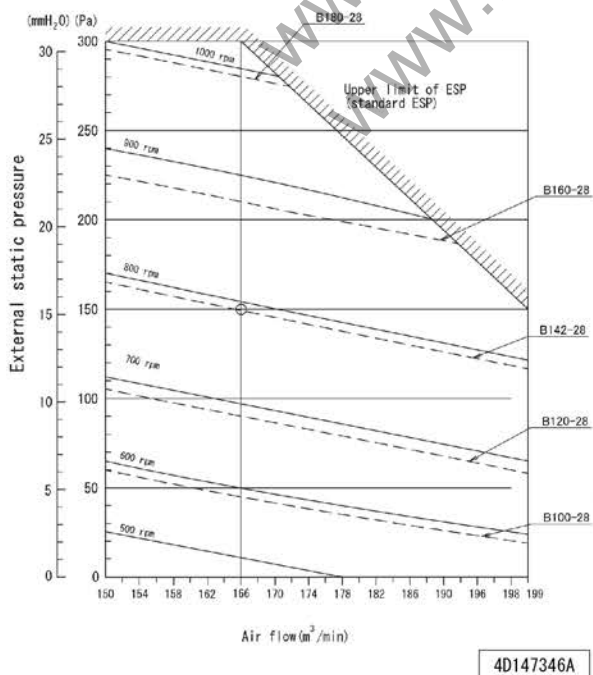

Wiring Diagrams

OUTDOOR UNIT

RZUR08/10PY2S

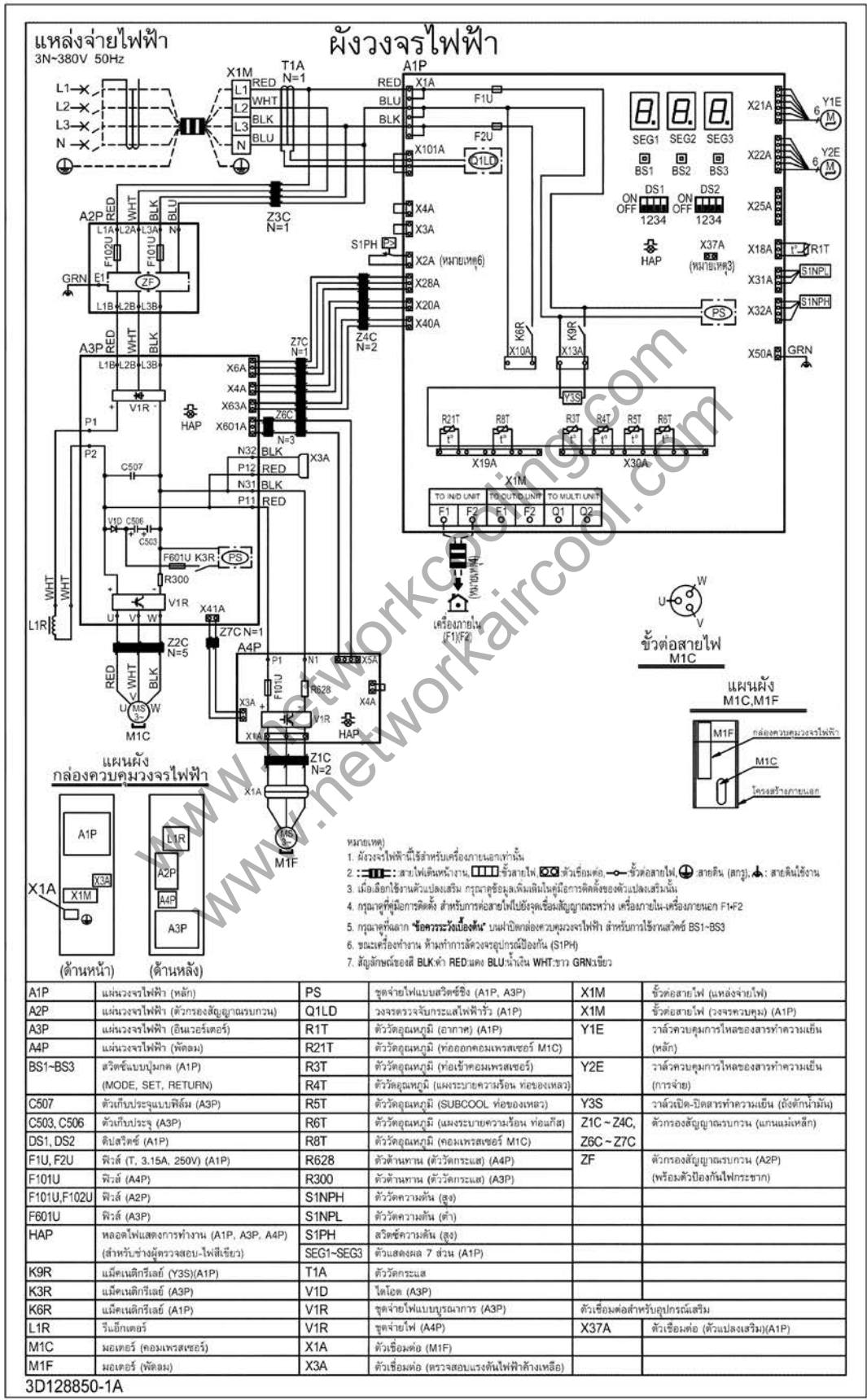

RZUR08QY2S

ผังวงจรไฟฟ้า

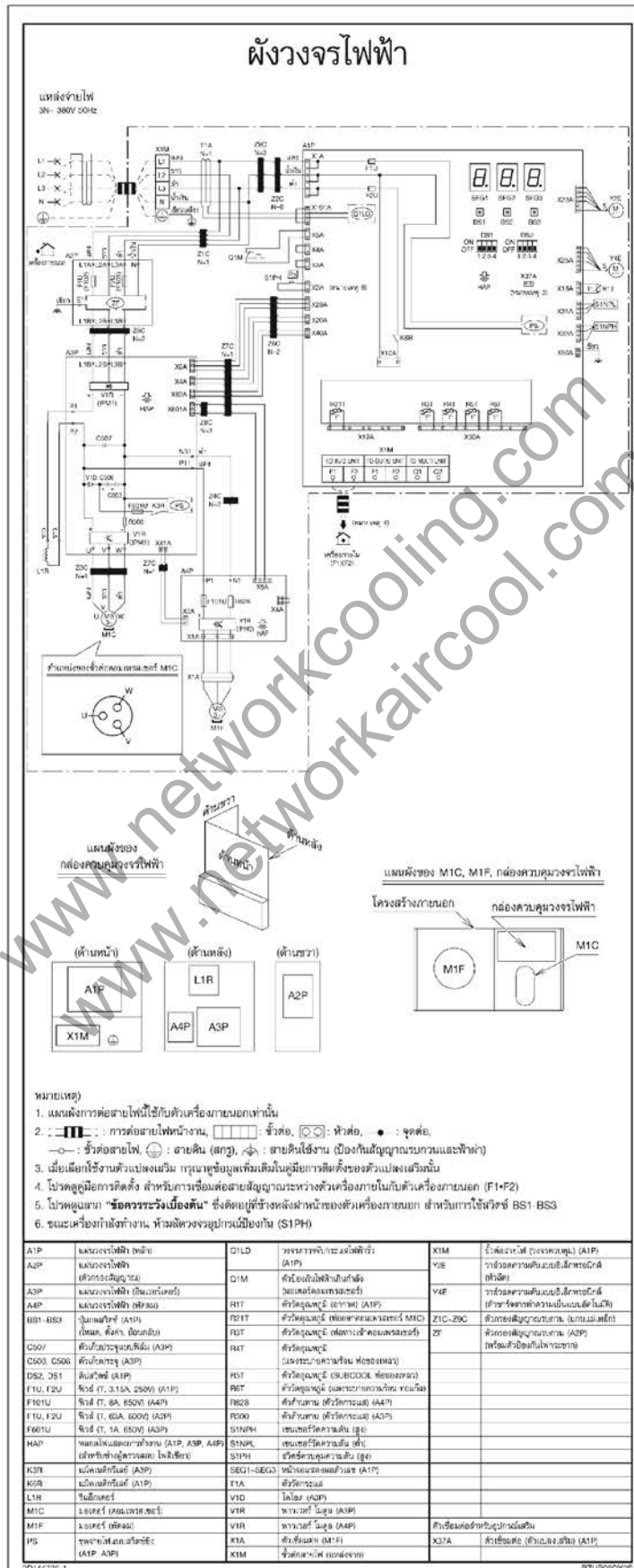

3D144276B

Piping Diagrams

OUTDOOR UNIT

RZUR08/10PY2S

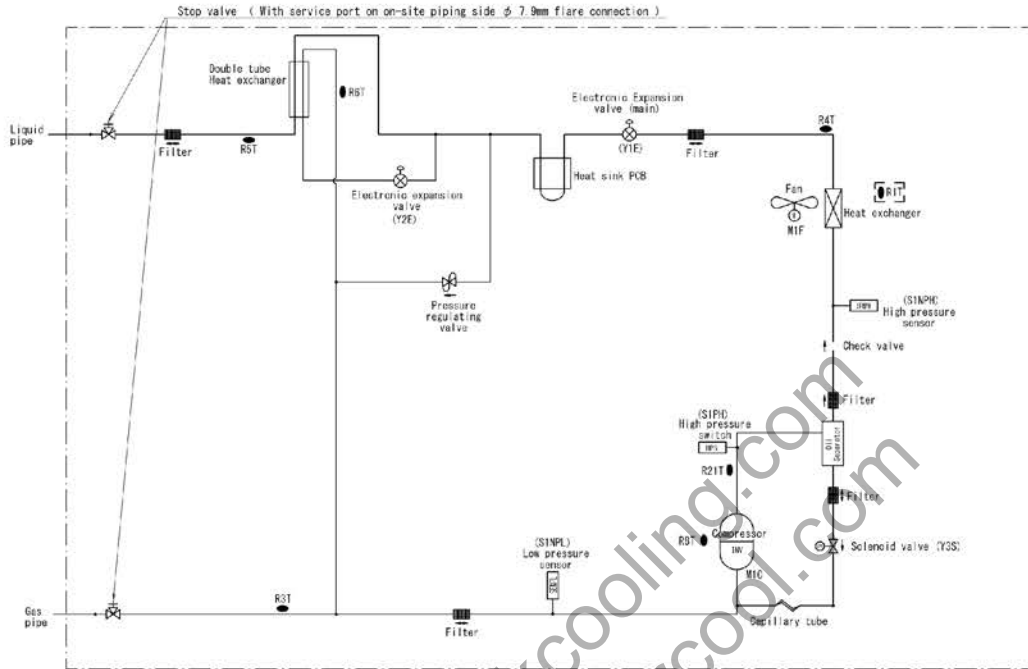

3D130368

RZUR08QY2S

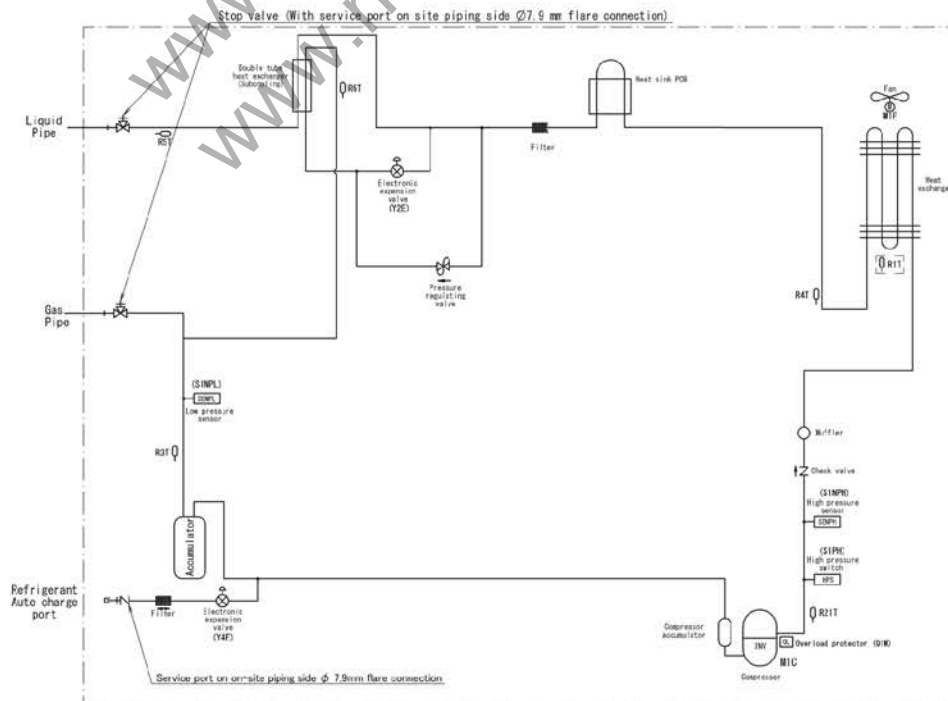

3D129633

RZUR10QY2S

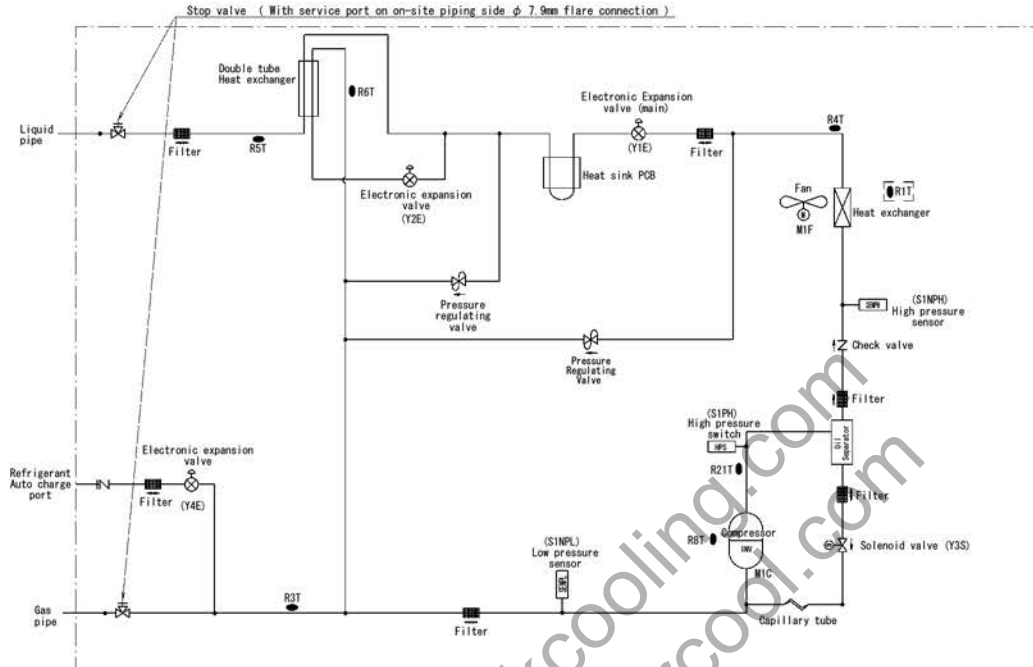

3D147181

RZUR12/16/18/20QY2S

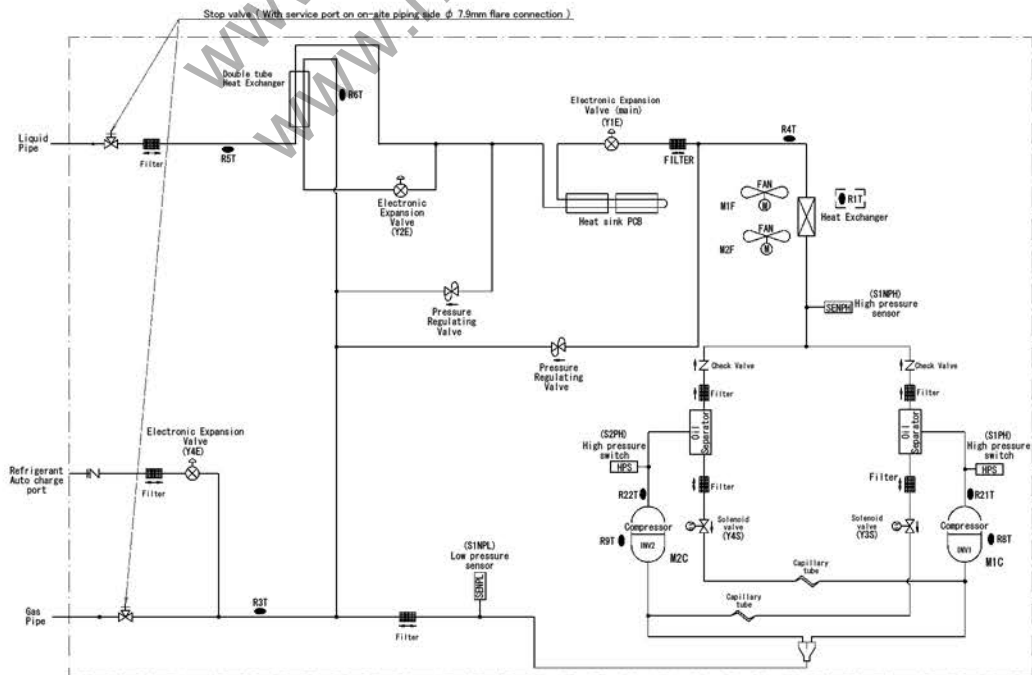

3D147180

Dimensions (Unit:mm)

FLOOR STANDING TYPE

DIRECT AIR BLOW

FVGR08PV2SR1
FVGR10PV2SR1

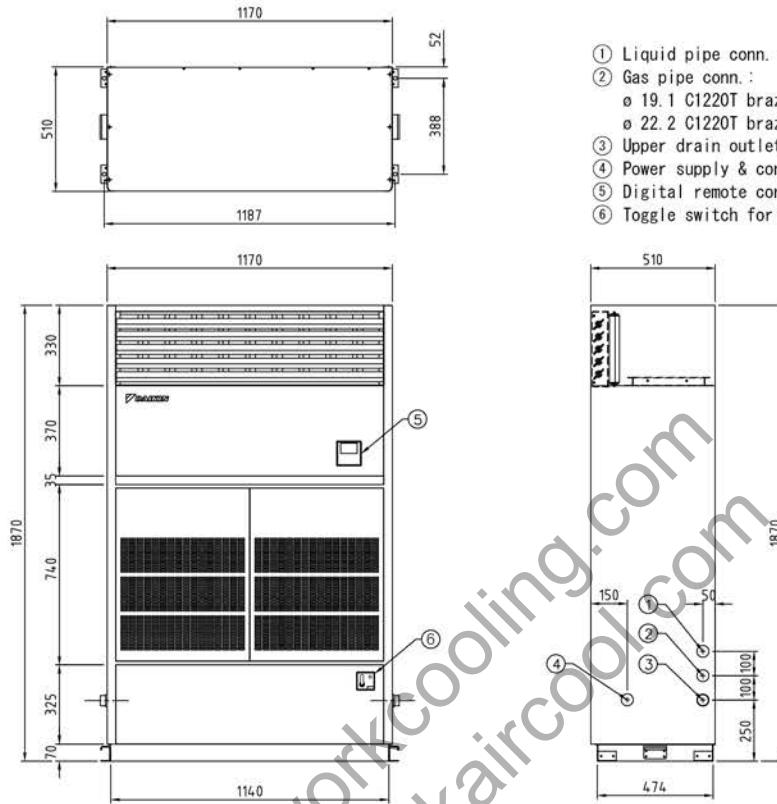

- ① Liquid pipe conn. ϕ 9.52 C1220T brazing
- ② Gas pipe conn. :
 ϕ 19.1 C1220T brazing for FVGR08PV2SR1
 ϕ 22.2 C1220T brazing for FVGR10PV2SR1
- ③ Upper drain outlet (PS 1B Internal thread)
- ④ Power supply & control wire intake
- ⑤ Digital remote controller
- ⑥ Toggle switch for FAN SPEED Hi/LOW

SDR3150215A

DUCT CONNECTION

FVPR10QY2S

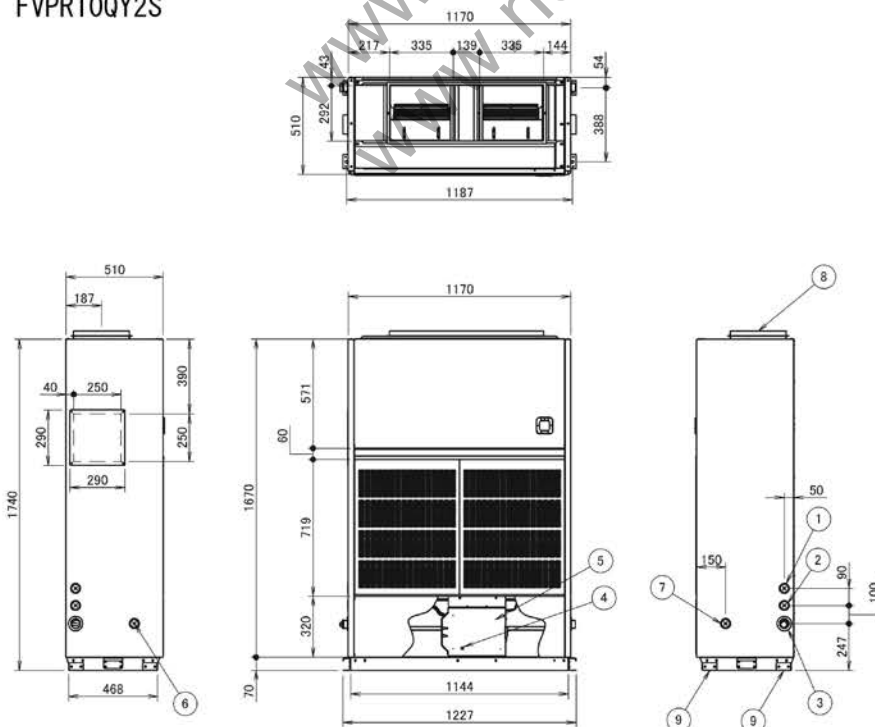

SERVICE SPACE NOTE 1)

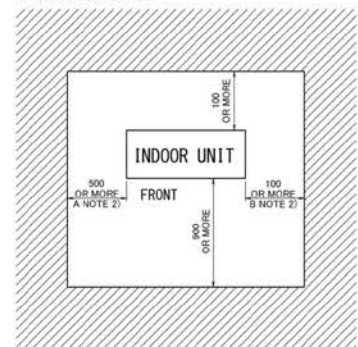

NOTE 1) IT SHOWS IN CASE OF LEFT SIDE PIPING.
(FACTORY DEFAULT IS LEFT SIDE PIPING.)
CHANGE TO RIGHT SIDE PIPING NEEDS FIELD WORK.)
2) REVERSE DIMENSION A TO B IN CASE OF RIGHT SIDE PIPING.

9	FOUNDATION BOLT	FOR M12 BOLT
8	AIR DISCHARGE FLANGE	
7	TRANSMISSION WIRING CONNECTION	
6	POWER SUPPLY WIRING CONNECTION	
5	CONTROL BOX	
4	EARTH TERMINAL (TERMINAL IN CONTROL BOX)	M4
3	DRAIN PIPE CONNECTION	PS 1B INTERNAL THREAD
2	GAS PIPE CONNECTION	ϕ 22.2
1	LIQUID PIPE CONNECTION	ϕ 9.5
ITEM	PART NAME	REMARK

3D147290A

DUCT CONNECTION

FVPR12QY2S
FVPR16QY2S

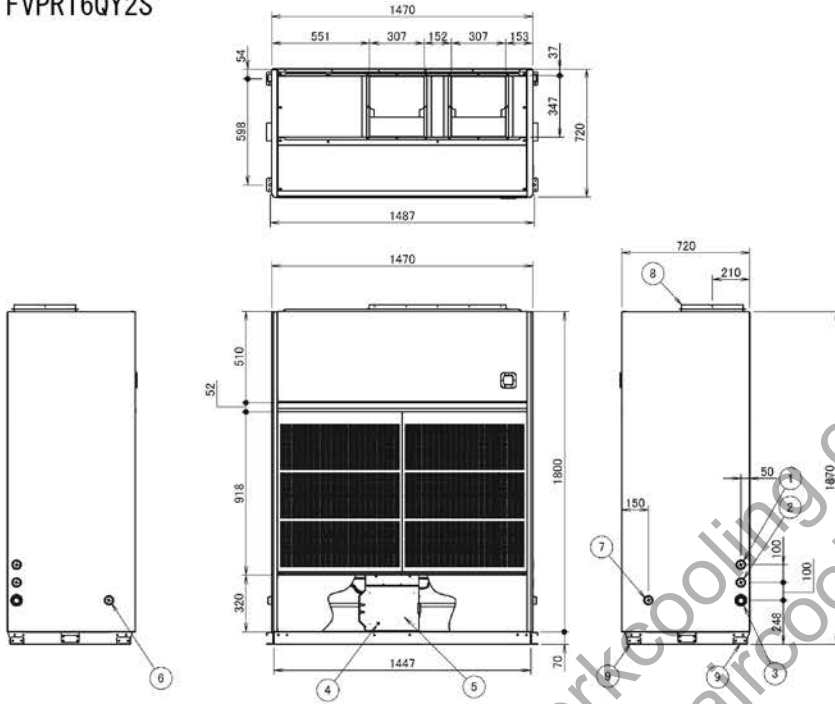

SERVICE SPACE NOTE 1)

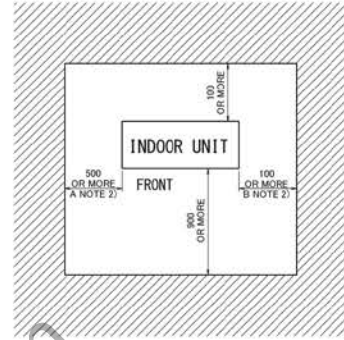

NOTE 1) IT SHOWS IN CASE OF LEFT SIDE PIPING.
(FACTORY DEFAULT IS LEFT SIDE PIPING.
CHANGE TO RIGHT SIDE PIPING NEEDS FIELD WORK.)
NOTE 2) REVERSE DIMENSION A TO B IN CASE OF RIGHT SIDE PIPING.

9	FOUNDATION BOLT	FOR M12 BOLT
8	AIR DISCHARGE FLANGE	
7	TRANSMISSION WIRING CONNECTION	
6	POWER SUPPLY WIRING CONNECTION	
5	CONTROL BOX	
4	EARTH TERMINAL (TERMINAL IN CONTROL BOX)	M4
3	DRAIN PIPE CONNECTION	PS 1B INTERNAL THREAD
2	GAS PIPE CONNECTION	φ 28.6
1	LIQUID PIPE CONNECTION	φ 12.7
ITEM	PART NAME	REMARK

3D147291A

DUCT CONNECTION

FVPR18QY2S
FVPR20QY2S

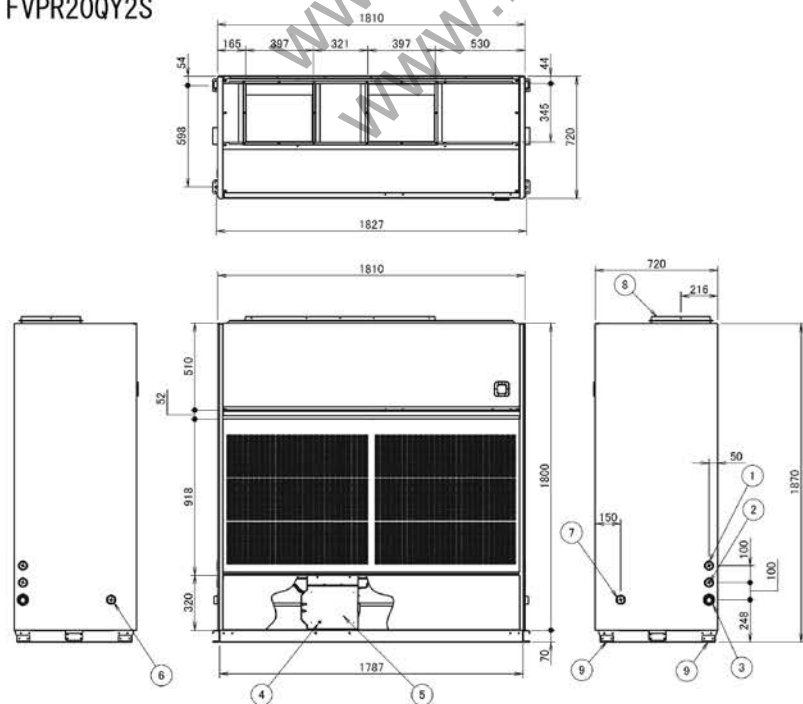

SERVICE SPACE NOTE 1)

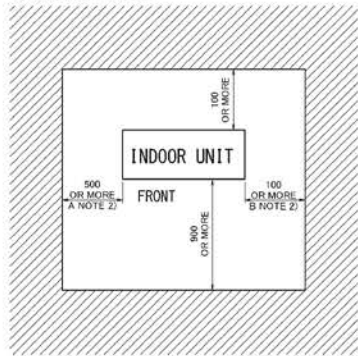

NOTE 1) IT SHOWS IN CASE OF LEFT SIDE PIPING.
(FACTORY DEFAULT IS LEFT SIDE PIPING.
CHANGE TO RIGHT SIDE PIPING NEEDS FIELD WORK.)
NOTE 2) REVERSE DIMENSION A TO B IN CASE OF RIGHT SIDE PIPING.

9	FOUNDATION BOLT	FOR M12 BOLT
8	AIR DISCHARGE FLANGE	
7	TRANSMISSION WIRING CONNECTION	
6	POWER SUPPLY WIRING CONNECTION	
5	CONTROL BOX	
4	EARTH TERMINAL (TERMINAL IN CONTROL BOX)	M4
3	DRAIN PIPE CONNECTION	PS 1B INTERNAL THREAD
2	GAS PIPE CONNECTION	φ 28.6
1	LIQUID PIPE CONNECTION	φ 15.9
ITEM	PART NAME	REMARK

3D147292A

Dimensions (Unit:mm)

DUCT TYPE

FDR08/10QY2S

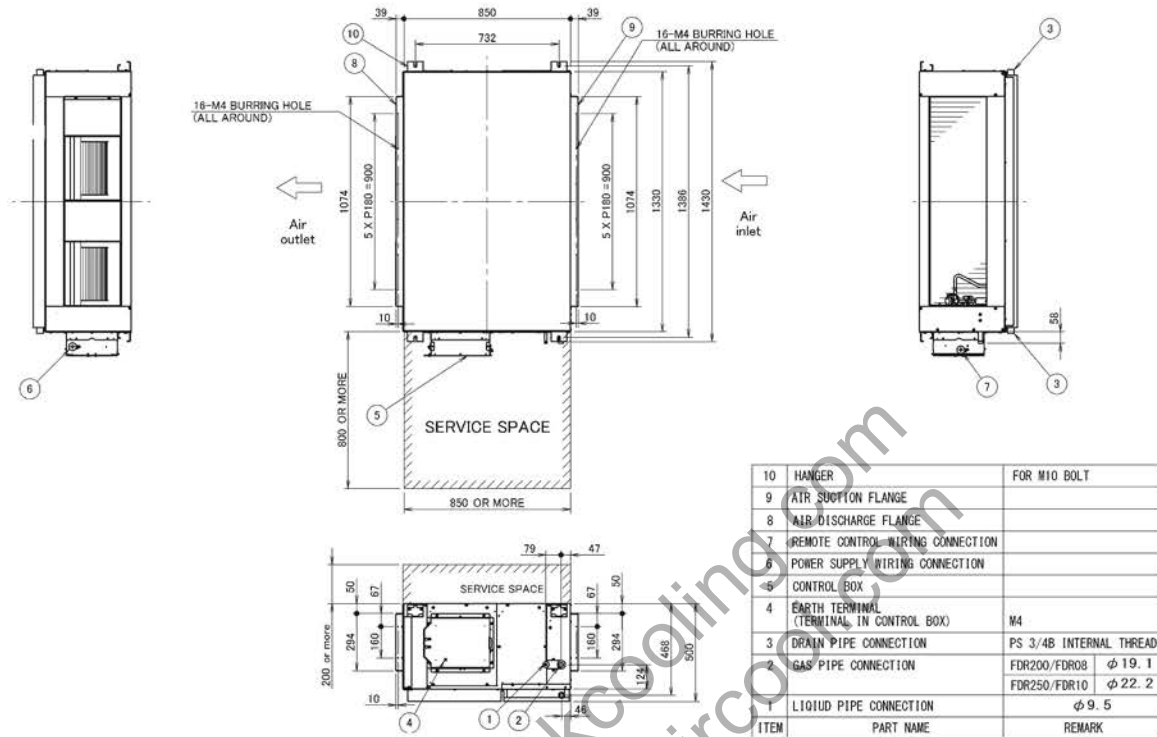

3D147287A

FDR12/16QY2S

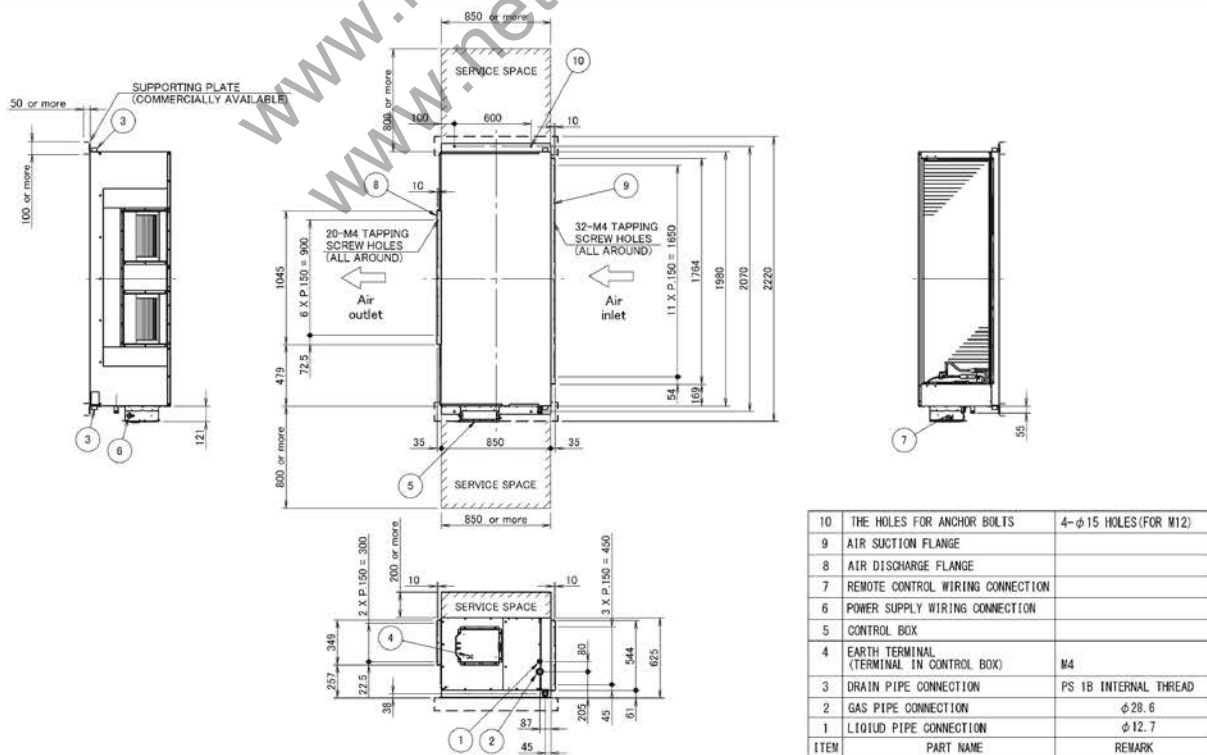

3D147288A

FDR18/20QY2S

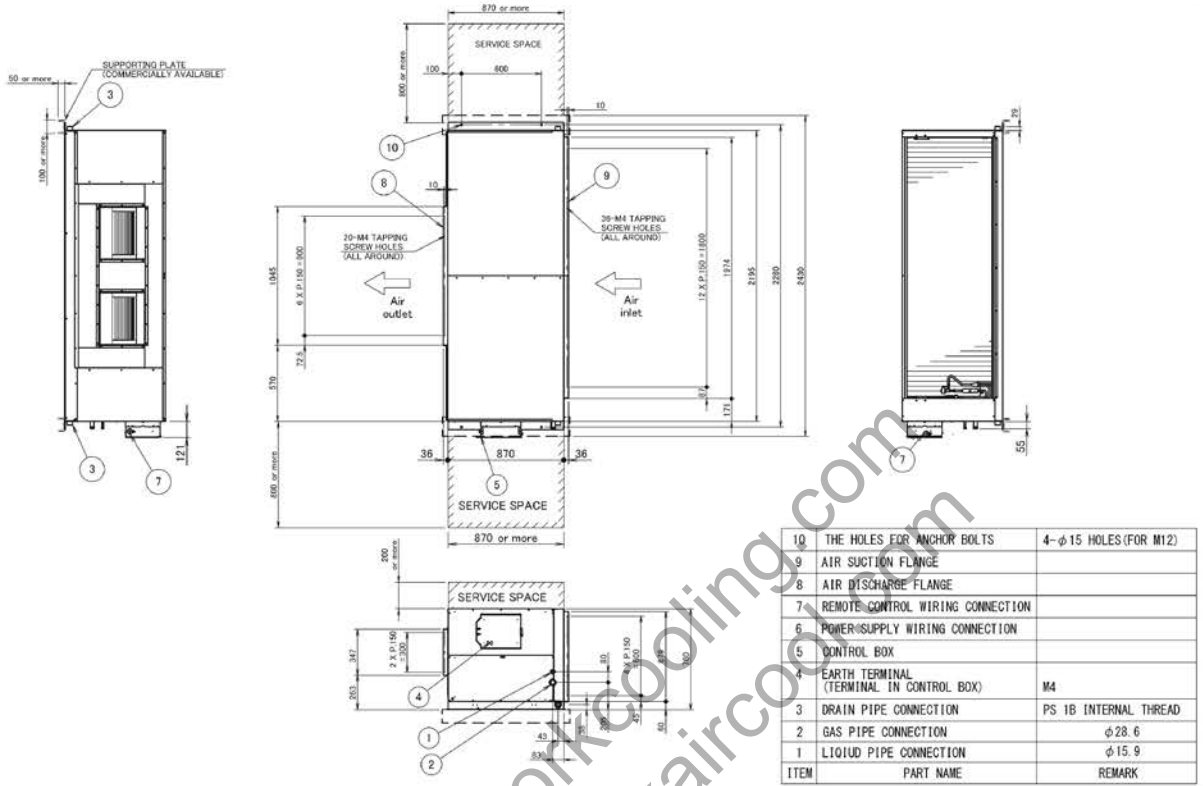

10	THE HOLES FOR ANCHOR BOLTS	4- ϕ 15 HOLES (FOR M12)
9	AIR SUCTION FLANGE	
8	AIR DISCHARGE FLANGE	
7	REMOTE CONTROL WIRING CONNECTION	
6	POWER-SUPPLY WIRING CONNECTION	
5	CONTROL BOX	
4	EARTH TERMINAL (TERMINAL IN CONTROL BOX)	M4
3	DRAIN PIPE CONNECTION	PS 1B INTERNAL THREAD
2	GAS PIPE CONNECTION	ϕ 28.6
1	LIQUID PIPE CONNECTION	ϕ 15.9
ITEM	PART NAME	REMARK

3D147289A

www.networkaircooling.com
www.networkaircooling.com

Dimensions (Unit:mm)

OUTDOOR UNIT

RZUR08/10PY2S

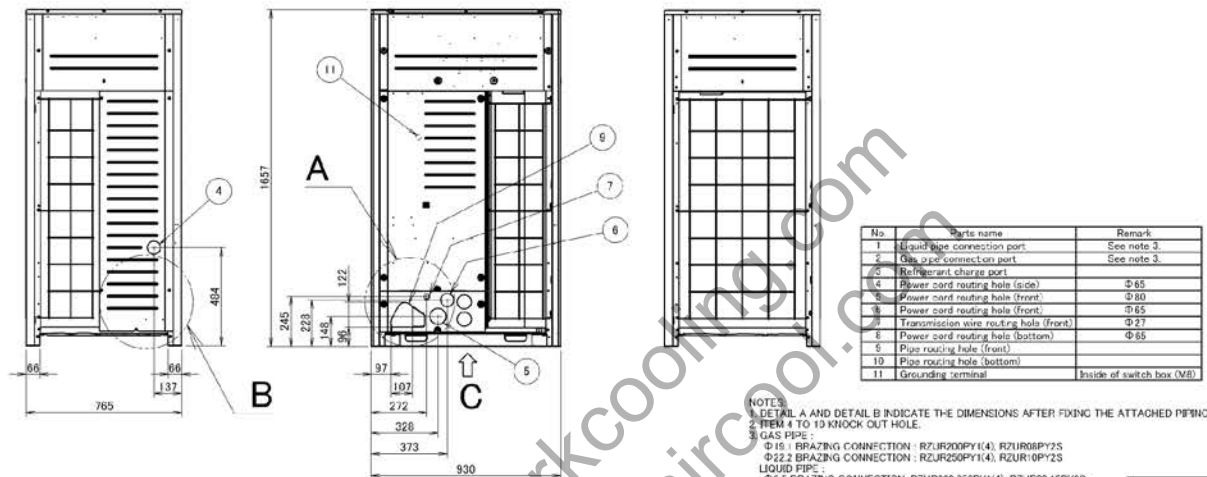
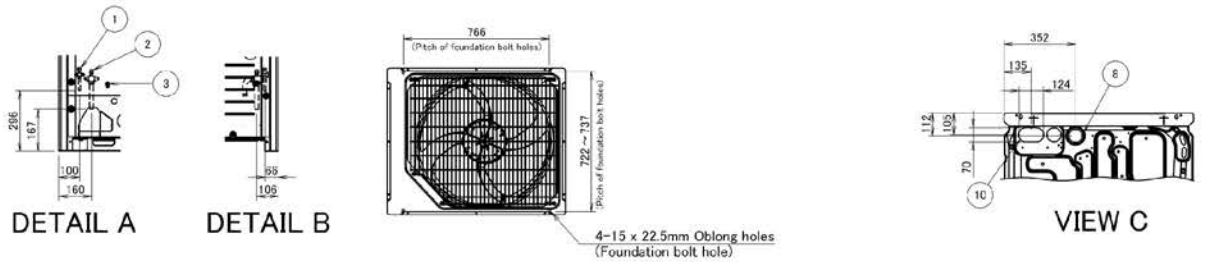

3D129057

RZUR08QY2S

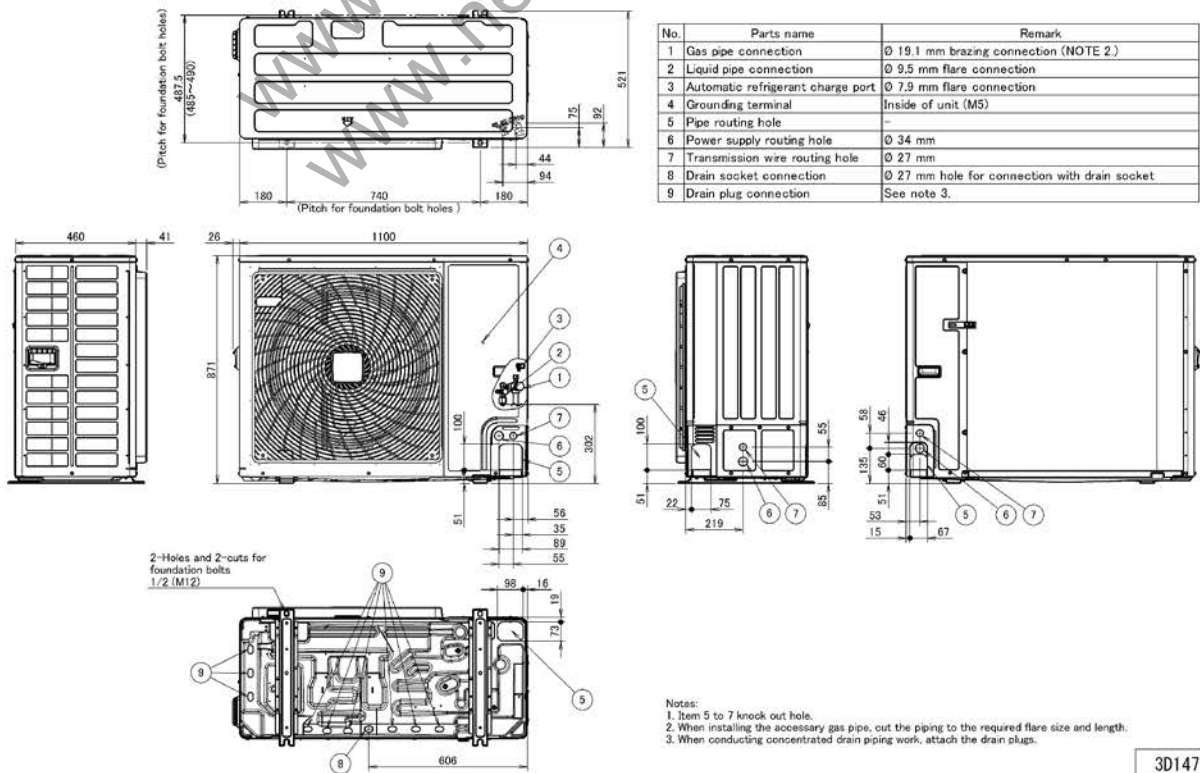

3D147199

RZUR10QY2S

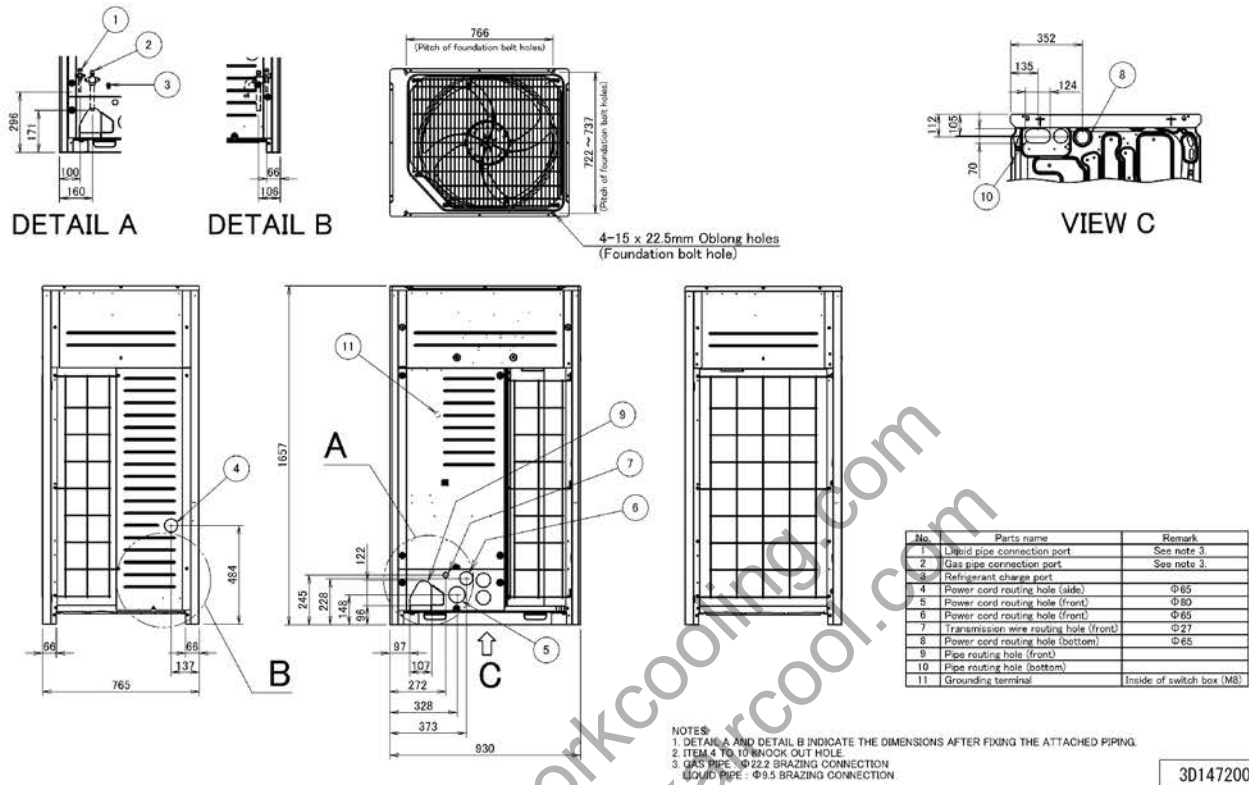

3D147200

RZUR12/16/18/20QY2S

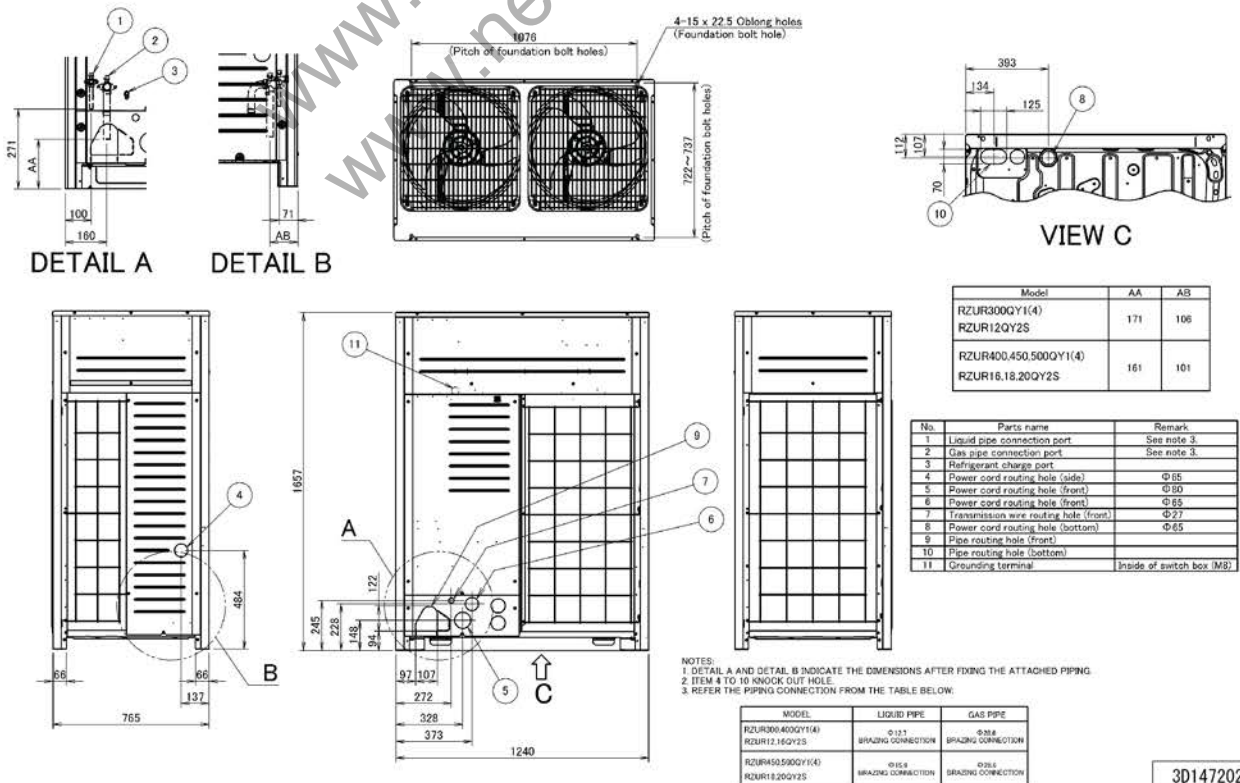

3D147202

Space required for indoor unit installation (Unit:mm)

FVGR08PV2SR1
FVGR10PV2SR1

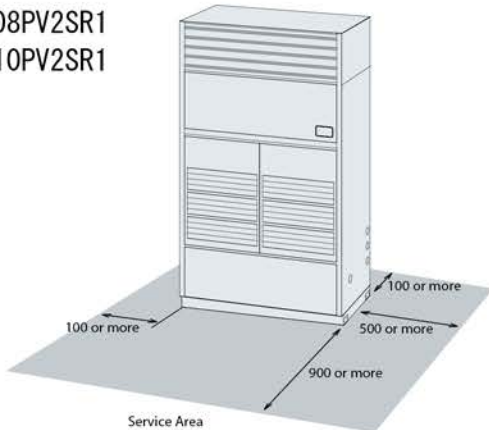

FVPR10QY2S
FVPR12QY2S
FVPR16QY2S
FVPR18QY2S
FVPR20QY2S

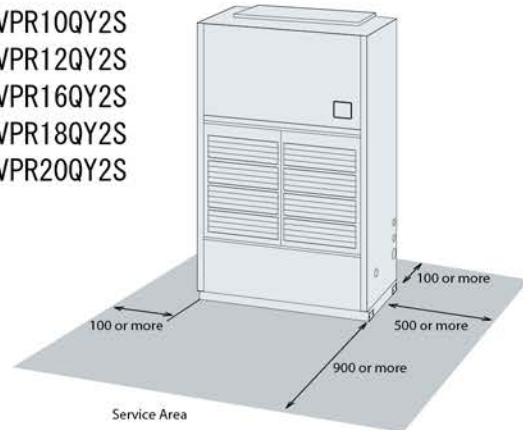

FDR08QY2S
FDR10QY2S

Provide enough clearance between the unit and the surrounding walls to prevent contact.

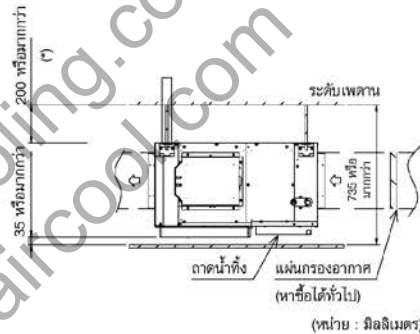
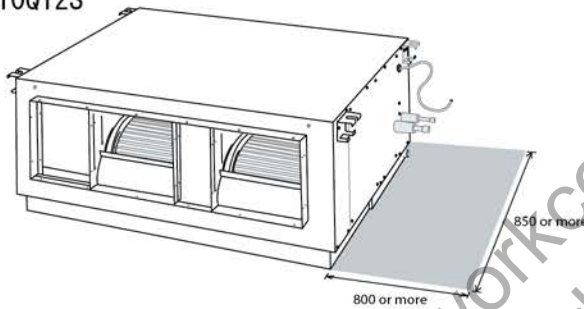

FDR12QY2S
FDR16QY2S

Provide enough clearance between the unit and the surrounding walls to prevent contact.

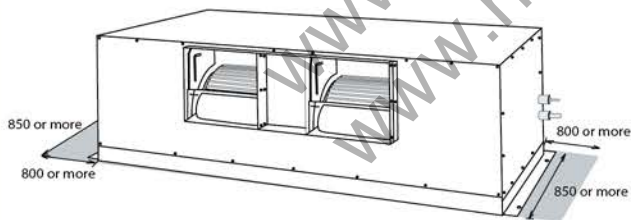

FDR18QY2S
FDR20QY2S

Provide enough clearance between the unit and the surrounding walls to prevent contact.

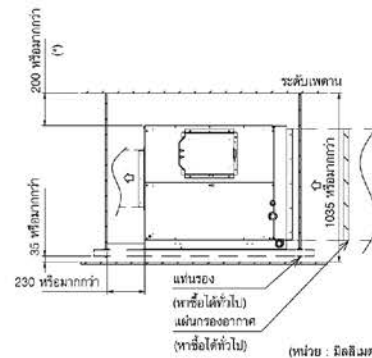
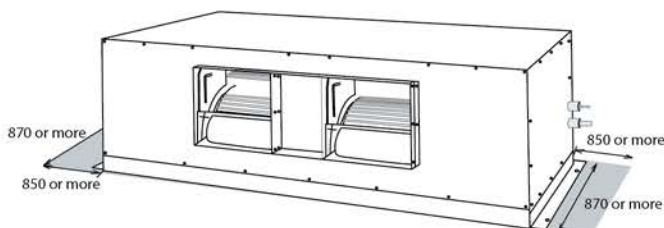

Space required for outdoor unit installation (Unit:mm)

RZUR08QY2S (Please refer to engineering databook for other installation patterns)

For side by side installation the connection piping is lead out from the front, the bottom and the side should keep the inter space over 100 mm. To lead out the piping from the back. The inter space over 250 mm. should be keep on the right side of the outdoor unit. The unit of the values is mm.

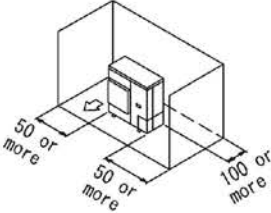
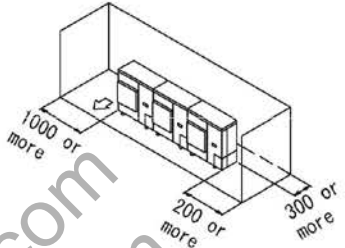
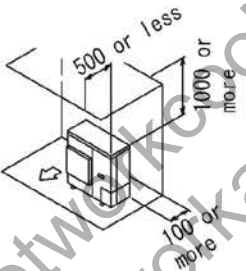
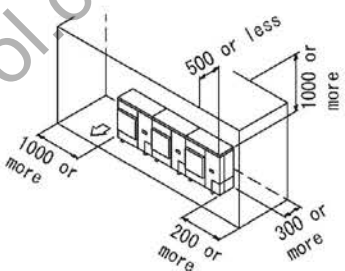
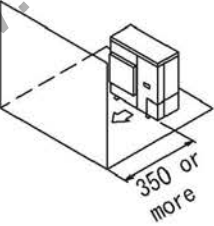
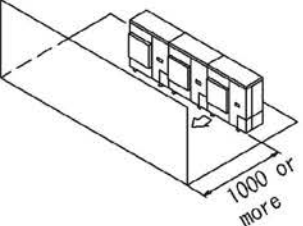
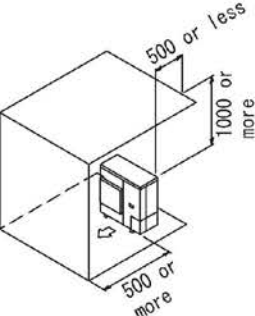
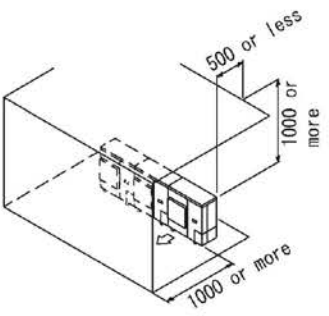
Obstacle	Single Unit Installation	Series Installation
Obstacle Suction Side + Both Side		
Obstacle Suction Side + Both Side + Above		
Obstacle Discharge Side		
Obstacle Discharge Side + Above		

Space required for outdoor unit installation (Unit:mm)

RZUR08PY2S / RZUR10PY2S / RZUR10QY2S / RZUR12QY2S / RZUR16QY2S / RZUR18QY2S / RZUR20QY2S

For single unit installation

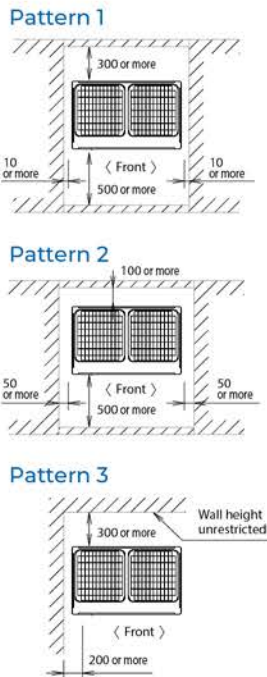

For installation in rows

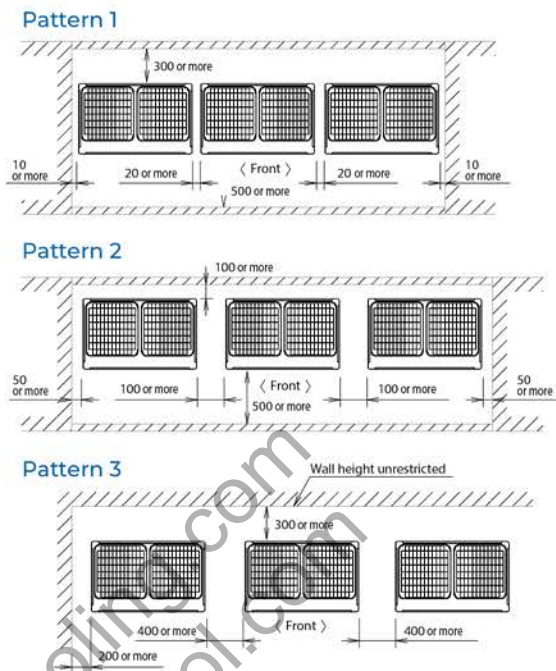

For centralized group layout

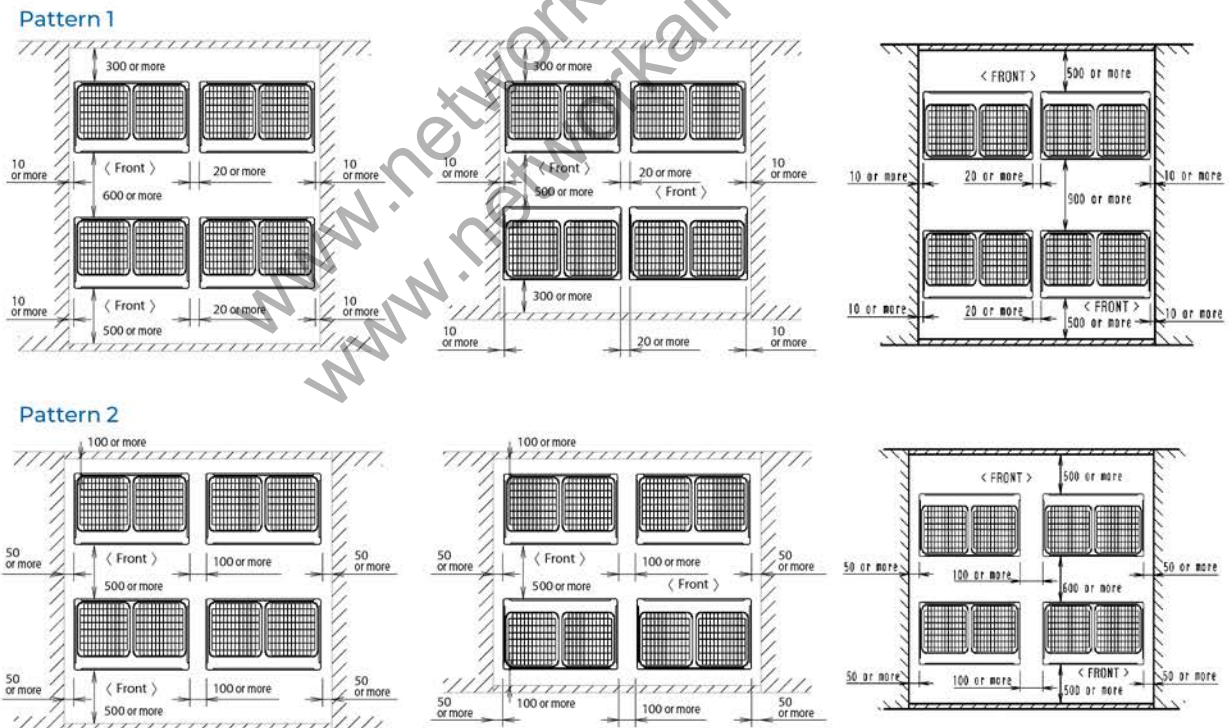

Notes: 1. Heights of walls in case of Patterns 1 and 2:

Front : 1500 mm
Suction side : 500 mm
Side : Height unrestricted.

Installation space to be shown in this drawing is based on the cooling operation at 35 degrees outdoor air temperature. When the design outdoor air temperature exceeds 35 degrees or the load exceeds maximum ability because of much generation load of heat in all outdoor unit, take the suction side space more broadly than the space to be shown in this drawing.

2. If the above wall heights are exceeded then h/2 and h/2 should be added to the front and suction side service spaces respectively as shown in the figure on the right.

3. When installing the units most appropriate pattern should be selected from those shown above in order to obtain the best fit in the space available always bearing in mind the need to leave enough space for a person to pass between units and wall and for the air to circulate freely.

(If more units are to be installed than are catered for in the above patterns your layout should take account of the possibility of short circuits.)

4. The units should be installed to leave sufficient space at the front for the on site refrigerant piping work to be carried out comfortably.

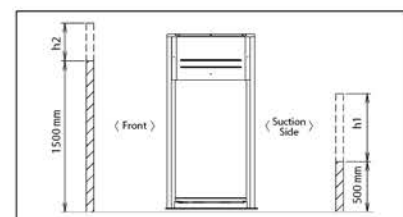

(Unit : mm)

Discharge grill Plenum Chamber

FLOOR STANDING TYPE

BPCV10Q

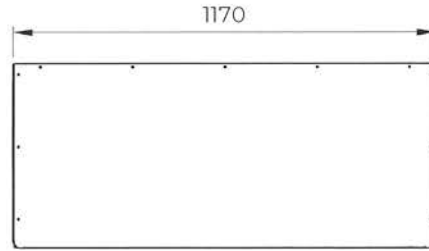
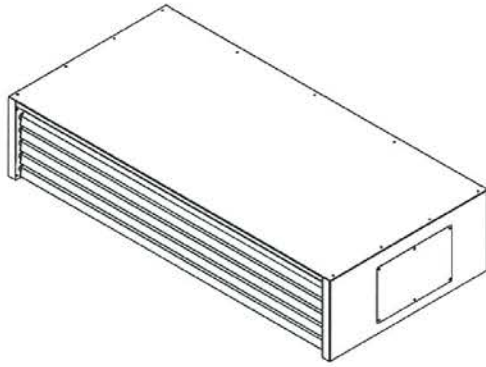

Top View



Front View

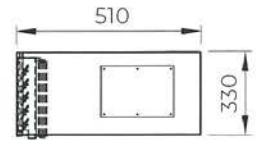

Side View

BPCV16Q

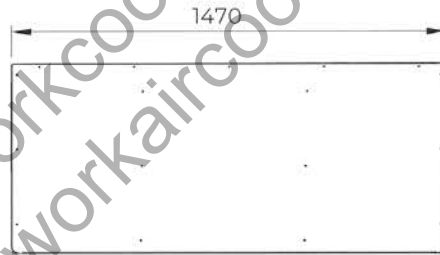
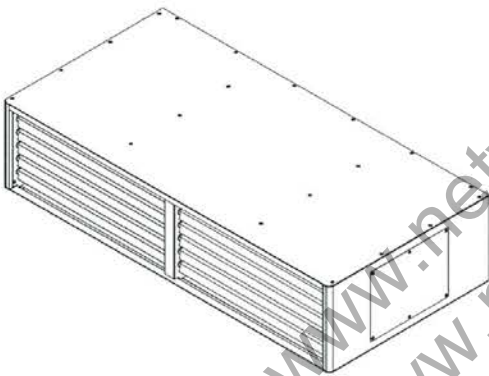

Top View

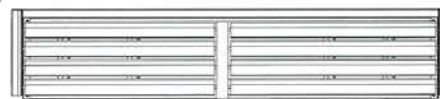

Front View

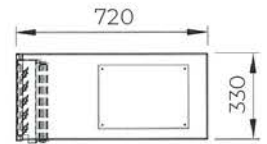

Side View

BPCV20Q

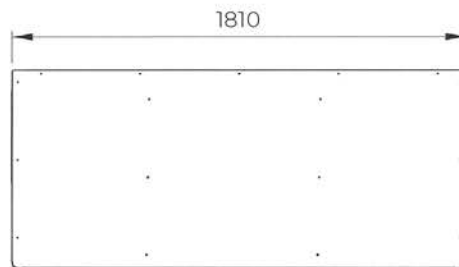
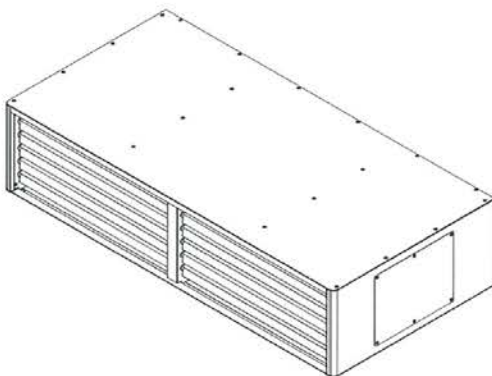

Top View



Front View

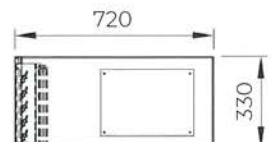

Side View

Space required for outdoor unit installation (Unit:mm)

DUCT TYPE

BPCD10Q

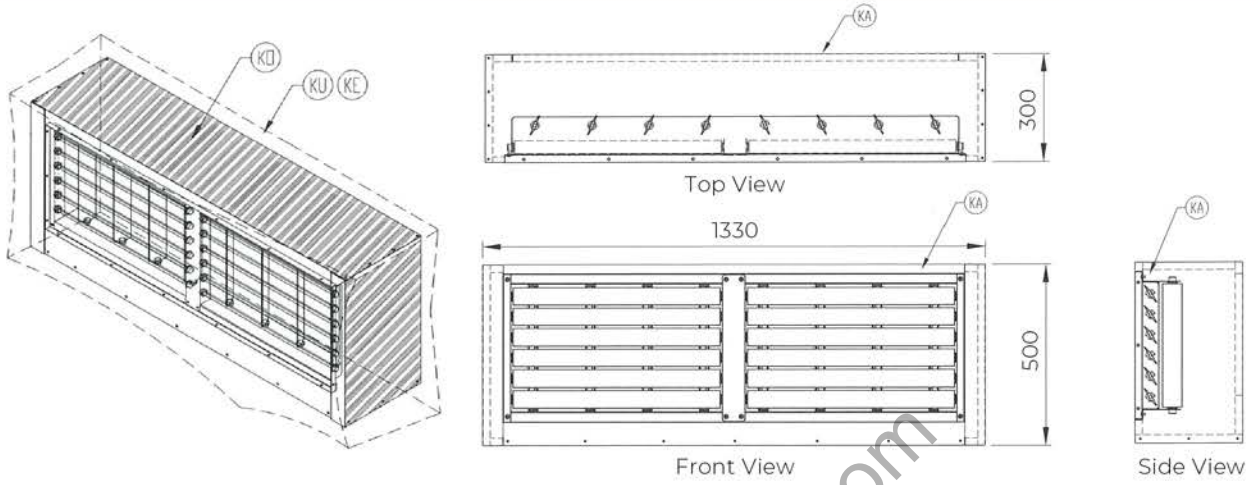

BPCD16Q

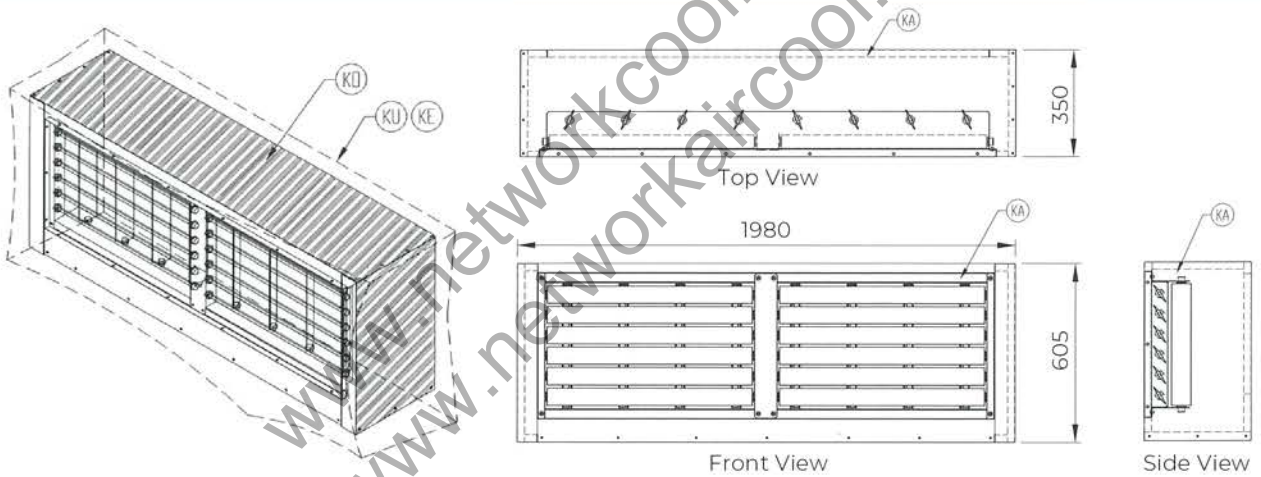

BPCD20Q

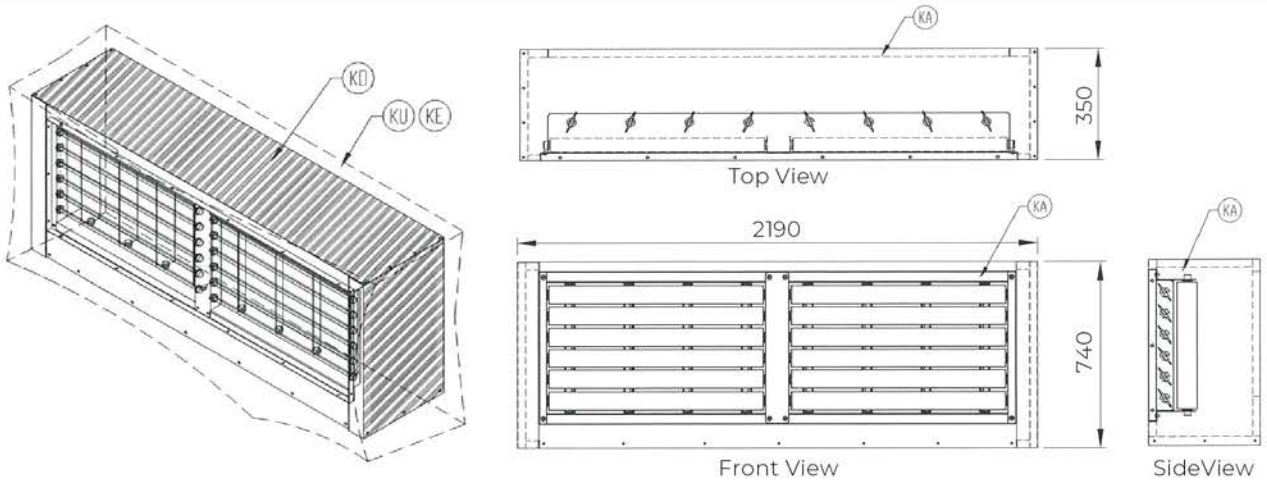

www.networkcooling.com
www.networkaircool.com

www.networkcooling.com
www.networkaircool.com

www.networkcooling.com
www.networkaircool.com

Warning

- Ask a qualified installer or contractor to install this product. Do not try to install the product yourself. Improper installation can result in water or refrigerant leakage, electrical shock, fire or explosion.
- Use only those parts and accessories supplied or specified by Daikin. Ask a qualified installer or contractor to install those parts and accessories. Use of unauthorised parts and accessories or improper installation of parts and accessories can result in water or refrigerant leakage, electrical shock, fire or explosion.
- Read the user's manual carefully before using this product. The user's manual provides important safety instructions and warnings. Be sure to follow these instructions and warnings.

Notice

- About harmonics, since this product is equipped with an inverter, harmonics will be generated. If local laws require the suppression of harmonics on the building, please take harmonic suppression measures on the electrical equipment side. Please contact your local sales company for details.

If you have any enquiries, please contact your local importer, distributor and/or retailer.

Cautions on product corrosion

1. Air conditioners should not be installed in areas where corrosive gases, such as acid gas or alkaline gas, are produced.
2. If the outdoor unit is to be installed close to the sea shore, direct exposure to the sea breeze should be avoided. If you need to install the outdoor unit close to the sea shore, contact your local distributor.

SIAM DAIKIN SALES CO.,LTD.

22 Soi Onnuch 55/1
Pravet Subdistrict, Pravet District,
Bangkok 10250

Tel. 0-2838-3200
Fax. 0-2721-7607

